

Operating instructions

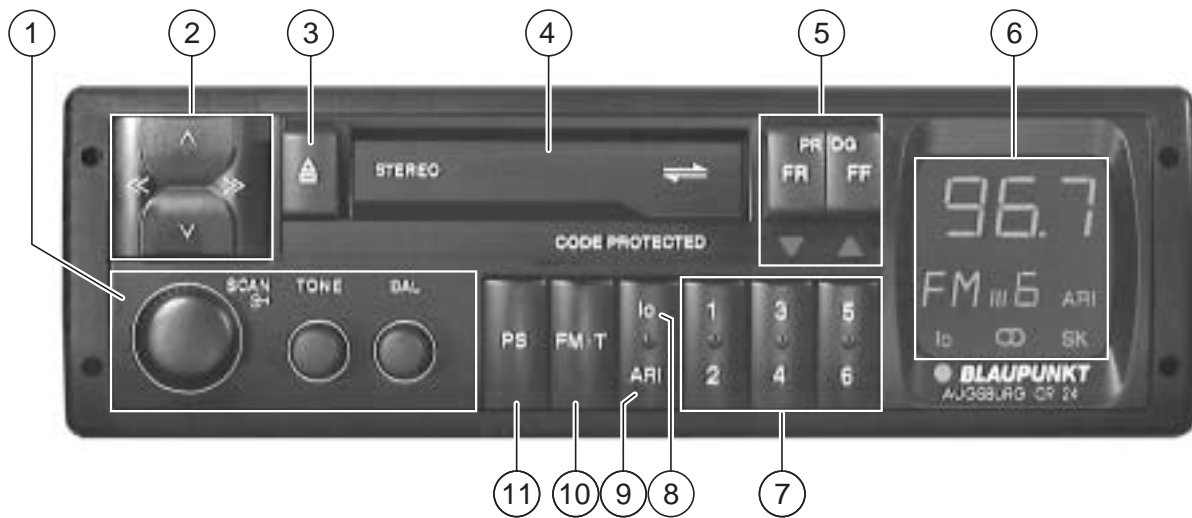

Augsburg CR 24



Contents

Short description	14	Radio operation	18	Tape operation	21
Important information	16	Station search	18	Inserting the tape	21
What you need to know!	16	Manual station search	18	Ejecting the cassette	21
Traffic safety	16	Adjusting the station search sensitivity .	18	Fast tape run	21
Installation/connection	16	Stereo - mono switch	18	Autoreverse function	22
Anti-theft coding	16	Changing the memory bank	18	Care of your audio equipment	22
Wrong code number entered	16	Storing stations	18	Appendix	22
Switching the code system on	17	Storing the strongest stations auto-	19	Technical data	22
Restart following interruption of power	17	matically with Travelstore	19		
supply	17	Recalling stored stations	19		
Switching the code system off	17	Sampling stored stations briefly with			
Optical indication of theft protection	17	Preset-Scan	18		
		Sampling stations briefly			
		with Radio-Scan	19		
		Traffic messages (ARI)	20		
		Switching the traffic messages (ARI)			
		on and off	20		
		Warning beep	20		
		Switching the warning beep off	20		
		Automatic search start	20		
		Adjusting the volume for traffic messages			
		and warning beep	21		

Short description

① Amplifier

On Off

Volume
Scan: Press for 1 second.

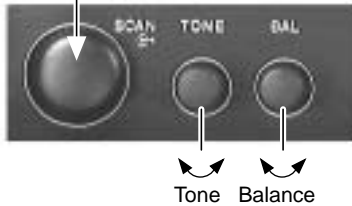

When “Cod” lights up in the display, read chapter “Anti-theft coding” first.

Balance

To adjust the volume of the left and right channel.

SCAN

Press for approximately 1 second to sample all stations to be received.

② Rocker switch

Station search

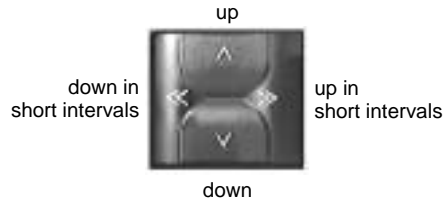

Extra function:

Coding

Confirm with after having entered the code.

③ Eject cassette tape

Press

④ Cassette tape slot

Insert cassette (side A or 1 facing up, the open side facing to the right).

⑤ Rapid tape run/Autoreverse

Switch-over to the other track

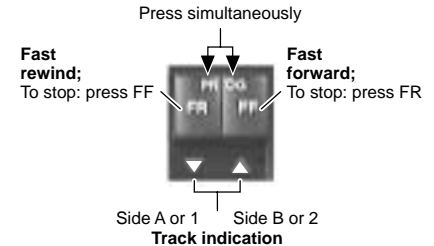

⑥ Display

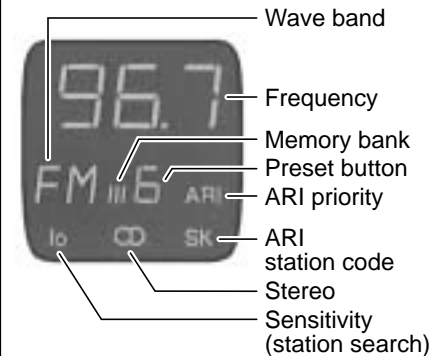

⑦ **1, 2, 3, 4, 5, 6 - preset buttons**

For each memory bank (I, II, III) you can store up to 6 stations.

To store a station: Press button during radio operation and hold it. First the station will be muted and then becomes audible again.

To recall a station: Select the memory bank using the **FM•T** button and press the respective preset button (press repeatedly if necessary).

Extra function:

Coding - Read chapter "Anti-theft coding" first.

Buttons **1, 2, 3, 4** - To enter the code. Press each button repeatedly until the code of the car radio pass is indicated in the display.

⑧ **lo**

Station search sensitivity
"lo" lit up in the display indicates normal sensitivity for the station search function (the system will pick up strong stations only).

"lo" not lit up in the display indicates high sensitivity for the station search function (the system will also pick up weaker stations).

To change the search sensitivity: press **lo**.

⑨ **ARI** - traffic messages

When ARI is visible in the display, you can only listen to those radio stations which broadcast traffic messages.

ARI on/off: press button.

⑩ **FM•T** - FM, Travelstore

Selector for the FM memory banks I, II, III and "T" (Travelstore).

To change the memory bank:

Press button until the desired memory bank is indicated in the display.

To store the six nearest, strongest stations automatically with Travelstore:

Store: Press **FM•T** until the search starts in the display.

Recall: Press **FM•T** until "T" appears in the display. Then briefly press one of the presets **1, 2, 3, 4, 5, 6**.

⑪ **PS (Preset-Scan)**

To sample all stored stations of the selected memory bank (FM I-III or T) briefly.

Important information

What you need to know!

Before starting to use your new car radio you should carefully read through the information on “Traffic safety” and “Anti-theft coding”.

Traffic safety

Traffic safety has always priority. Use your car radio in such a manner that you are always able to cope with and react to the prevailing traffic situation at any given time. Remember, even at 50 km/h you are still moving at a speed of 14 m per seconds.

It is also very important that you are able to hear, and react to, acoustic warning signals around you, for example from the police or the firebrigade.

Therefore, adjust the volume reasonably.

Installation/connection

The code system can only be switched on and off, if the radio is connected to permanent power.

If you like to install your new car radio by yourself or add other audio components to the existing ones, then please read carefully the enclosed instructions on installation and connection.

Do not connect the loudspeaker outputs to ground!

Only use the accessory and replacement parts approved by Blaupunkt.

Anti-theft coding

The car radio comes standard with the code system deactivated.

If the anti-theft coding system is on while the power supply to the unit is interrupted (e.g. theft, disconnecting the car battery), the set is electronically blocked. Then it may only be used again after the appropriate code number has been entered (see car radio passport).

Wrong code number entered

It should not be possible for thieves to ascertain the code number by trial-and-error. This is why the set will be blocked for a certain period of time, if an incorrect code number is entered. In this case, “- -” will appear in the display.

This waiting time is 10 seconds after the first three attempts, and 1 hour following subsequent attempts.

After 19 unsuccessful attempts, “OFF” will appear in the display and the set can no longer be restarted.

Note:

Keep your car radio passport with the code number in a safe place in order to avoid “unauthorized access” to your car radio.

If the power supply to the radio is interrupted while the code system is switched on, you need to know the right code number.

The radio will operate again as soon as you have entered the right code number.

If you lose your radio passport and have forgotten your code number, you will not be able to restart the set after the power supply has been interrupted. In this case, your radio can only be reset in our central customer service workshop or in one of our service agencies abroad.

Switching the code system on

Precondition:

The radio must be connected to permanent power.

In order to switch the code system on:

- Turn the radio off.
- Hold down the preset buttons **1** and **4** simultaneously.
- Turn the radio on.
“Cod” briefly appears before the radio begins to operate.
- Release preset buttons **1** and **4**.

The code system is on.

“Cod” will be briefly displayed each time the radio is turned on.

Restart following interruption of power supply (Code system switched on)

- Switch on the set.
“Cod” will appear in the display.
- Briefly press preset button **1**, “000” will appear in the display.
- Enter the code number given in the Blaupunkt car radio passport:
Preset button **1** only allows to choose “0” or “1”. The first “0” will not be displayed.
Example: the code number is 0521.
 - Press preset button **1** until “000” appears in the display.
 - Press preset button **2** five times, “500” appears in the display.
 - Press preset button **3** twice, “520” appears in the display.
 - Press preset button **4** once, “521” appears in the display.
- To confirm the code number:
Press the upper part of the rocker switch \wedge .

Your car radio is now ready for operation.

If three dashes appear again in the display, you have entered a wrong code number.

Now it is essential to enter the correct code after the waiting period has elapsed (Cod in the display).

If the radio is turned off before the waiting period has elapsed, then the waiting period restarts as soon as the radio is turned on again.

Switching the code system off

- Turn off the radio.
- Simultaneously press preset buttons **1** and **4** and hold them down.
- Turn the set on.
“Cod” will appear in the display.
- Enter the code number given in the Blaupunkt car radio passport and confirm: See example “Restart following interruption ...”.

The code system is now deactivated.

Optical indication of theft protection

As optical warning of the encoded car radio, the LED \blacktriangledown ⑤ flashes when the ignition is switched off, provided the car radio has been connected correspondingly.

For this, please read through the installation instructions.

Radio operation

With this car radio you can receive FM frequencies ranging from 87.5 to 108 MHz.

Station search

- Press \wedge/\vee , the car radio will then automatically tune into the next station.

If you hold the upper or lower part \wedge/\vee of the rocker switch depressed, the search function will forward quickly in the corresponding direction.

Station search

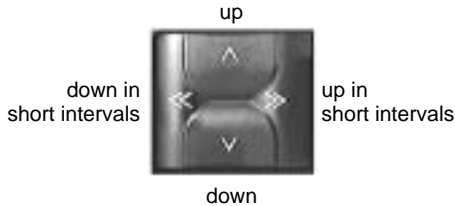

Manual station search << >>

- Press << or >>, the frequency will then move up or down in short intervals.

If you hold the rocker switch depressed, then the frequencies will move up or down more quickly.

Adjusting the station search sensitivity

You can adjust the sensitivity of the automatic station search.

For this,

- press **lo**.
When "lo" is visible in the display, then only those stations with relatively strong signals will be picked up (low sensitivity).
When "lo" is not visible in the display, then stations with weaker signals will also be picked up (high sensitivity).

Stereo - mono switch

You can switch to mono when the reception conditions are only poor:

- Press **lo** for approximately 2 seconds. During mono reception the stereo sign \odot will go out in the display.

Each time the car radio is switched on, the reception will automatically be set to stereo. The radio will automatically shift to mono when the reception conditions are poor.

Changing the memory bank

You can shift between the memory banks I, II, III and T to store and recall the stored stations.

The selected memory bank is indicated in the display.

- Press **FM•T** until the desired memory bank is indicated in the display (press repeatedly if necessary).

Storing stations

For each memory bank (I, II, III, T) you can store up to six stations using the preset buttons **1, 2, 3, 4, 5, 6**.

- Select the memory bank by pressing **FM•T**.
- Use the rocker switch to tune in a station (either automatically or manually).
- Press the desired preset button and hold it. First the station will be muted and then becomes audible again (after approximately 2 seconds).

Now the station has been stored in the respective memory bank.

The activated preset button is indicated in the display.

Note:

If you tune into a station which has already been stored on another memory bank, the corresponding preset button and the memory bank will start flashing on the display for approximately 5 seconds.

Storing the strongest stations automatically with Travelstore

In your respective reception area you can automatically store the six strongest FM stations, sorted according to their frequencies. This feature is particularly useful when you are travelling.

- Press **FM•T** for at least 2 seconds.

The radio will search for the nearest FM stations and store them in the memory bank "T" (Travelstore). When the process has been completed, the first station will be set.

If you wish, you can also store stations in the Travelstore memory bank manually (see "Storing stations").

Recalling stored stations

You can recall any stored station by pressing the corresponding button.

- Select the memory bank.
For this, press **FM•T** until the desired memory bank is indicated in the display.
- Briefly press the corresponding preset.

Sampling stored stations briefly with Preset-Scan

You can briefly sample all stored stations of a memory bank using the Preset-Scan function.

- Press **PS**,
the set will sample all stations of the selected memory bank I, II, III or "T" briefly one after another.

Free preset buttons will be skipped.

To stop this function:

- Press **PS** once again.
The radio will continue to play the currently sampled station.

Sampling stations briefly with Radio-Scan

Starting with the currently played station you can sample the following ones one after another for approximately 8 seconds each:

- Press knob ① for approximately 1 second.

As soon as the following station is found, it will be sampled for approximately 8 seconds. The corresponding frequency starts flashing in the display; if this station has been already stored, then the corresponding preset button and memory bank will also light up in the display. When the sampling period has elapsed, the radio will start sampling the next station.

To keep on listening to a sampled station:

- Press knob ① once again.
The Scan function is off.

If no station is selected during the sampling process, the set will start playing the station from which the search operation has been started before.

Traffic messages (ARI)

Many FM stations broadcast traffic messages for their reception area at regular intervals.

Stations using the ARI system also broadcast an “ARI signal” during their programmes, so that your car radio can recognize them.

Another signal is broadcast to indicate the beginning and end of a traffic message.

Traffic messages are broadcast at a preset volume, the level of which can be regulated (see “Adjusting the volume for traffic messages and warning beep”). If you are playing a cassette, it will be interrupted until the traffic message has ended and will then resume operation.

Switching the traffic messages (ARI) on and off

If you want to switch the reception of traffic messages (ARI) on and off,

- press **ARI**.
When the reception of traffic stations is activated, “ARI” will light up in the display.

Now the radio will only pick up those stations broadcasting an ARI signal.

Warning beep

Should you leave the reception area of the station you are tuned to, then you will hear a warning beep after approximately 30 seconds.

If you should press a preset button for a station which does not broadcast the ARI signal, then you will also hear a warning beep.

Switching the warning beep off

a) Tune to a different station broadcasting the ARI signal:

- Press the rocker switch ② or
- activate a preset button with a station that broadcasts the ARI signal.

or

b) Switch the traffic message priority off:

- Press **ARI**.
“ARI” goes out in the display.

Automatic search start (during cassette operation)

If you should leave the reception area of your ARI station while you are playing a cassette, then the car radio will automatically tune into a different station broadcasting the ARI signal.

If no such ARI station is found within approximately 30 seconds after the search function has started, the cassette will stop and you will hear a warning beep.

Switch the warning beep off as described above.

Tape operation

Adjusting the volume for traffic messages and warning beep

The volume for traffic messages and warning beep has been preset at the factory. However, you can adjust it to suit your personal needs.

- Tune into a traffic station ("SK" lights up in the display).

Switch on the priority for traffic messages:

- Press **ARI**.
- Turn down the volume.

Slightly pull out the (connected) set and carefully adjust the desired volume while a traffic message is broadcast. Use an appropriate screw driver with a maximum blade width of 3 mm.

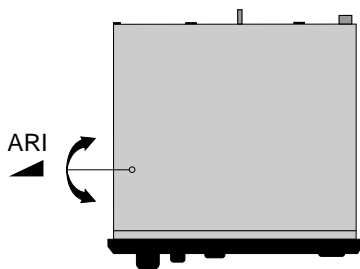

Inserting the tape

- Turn the set on.
- Insert a cassette.

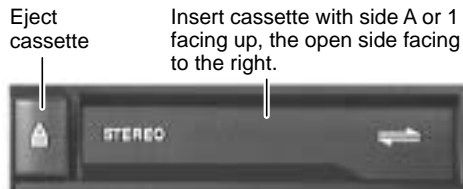

The cassette will be played in the direction used last.

Ejecting the cassette

- Press **▲**.
The cassette will be ejected.

Fast tape run

Fast forward

- Press **FF** (fast forward).
At the end of the tape, the set will switch to the other track and start playing.

Stop fast forward

- Press **FR**.

Fast rewind

- Press **FR** (fast rewind).
When the tape has rewound to the beginning, the set will switch to play the same track again.

Stop fast rewind

- Press **FF**.

Switch-over to the other track

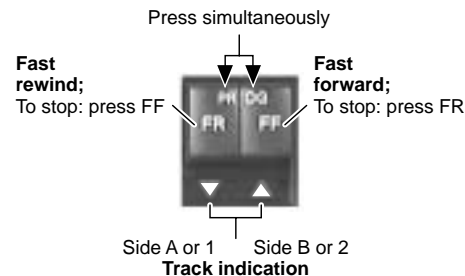

Appendix

Autoreverse function

(Switching tracks during playback)

- Press **FR** and **FF** at the same time.

At the end of the tape, the unit will automatically switch to the other track.

Note:

If there is too much tension on the cassette tape during playback, the set may switch to the other track by itself. In this case check the condition of the tape. Sometimes it helps to rewind the cassette tape completely.

Care of your audio equipment

We recommend that you use only C60/C90 cassette tapes in your car radio. Protect your cassettes from dirt, dust and temperatures exceeding 50 °C.

During cold weather, allow cold cassettes to warm up somewhat before playing them in order to avoid uneven tape transport. Operating problems and sound distortions may occur after approximately 100 hours of playing time and are caused by dust particles which adhere to the rubber roller and the audio head.

Use a cleaner cassette to remove normal dirt build-up. If more dirt than usual has accumulated, use a cotton bud dipped in rubbing alcohol to clean these parts. Never use any hard tools.

Technical data

Amplifier:

Output power: 2 x 10 W RMS power according to DIN 45324/3.1 into 2 Ω

FM:

Sensitivity: 0.9 μV at 26 dB signal-to-noise ratio

Frequency response: 35 - 15 000 Hz (-3 dB)

Cassette:

Frequency response: 40 - 14 000 Hz (-3 dB)

Subject to modifications!

Blaupunkt-Werke GmbH
Bosch Gruppe

K7/VKD 3 D93 162 014